

Montana's Wood Products Industry Update

Status and Trends

Montana Economic Outlook Seminar

Samuel Scott

Forest Economist

Bureau of Business and Economic Research



**FOREST INDUSTRY
RESEARCH PROGRAM**
UNIVERSITY OF MONTANA

Montana's Forest Products Industry

Regional Wood Products Supply Chain

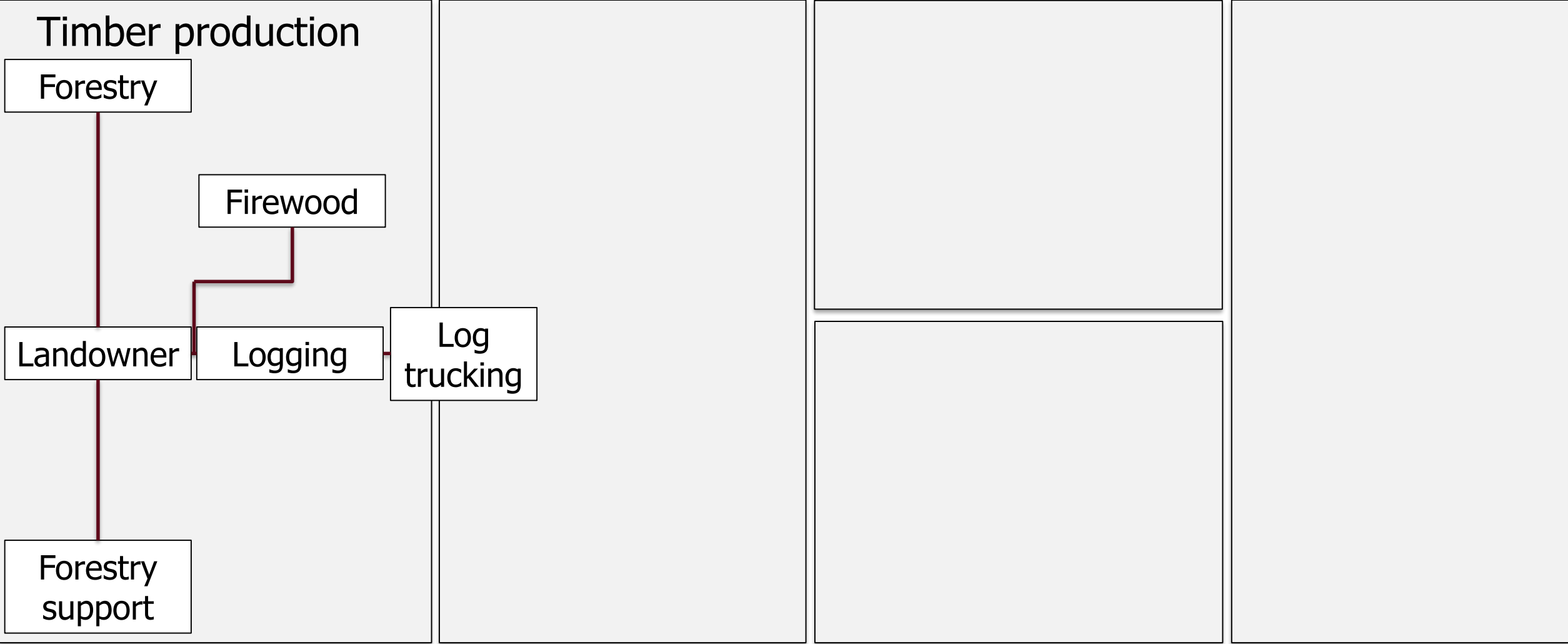

Regional Wood Products Supply Chain

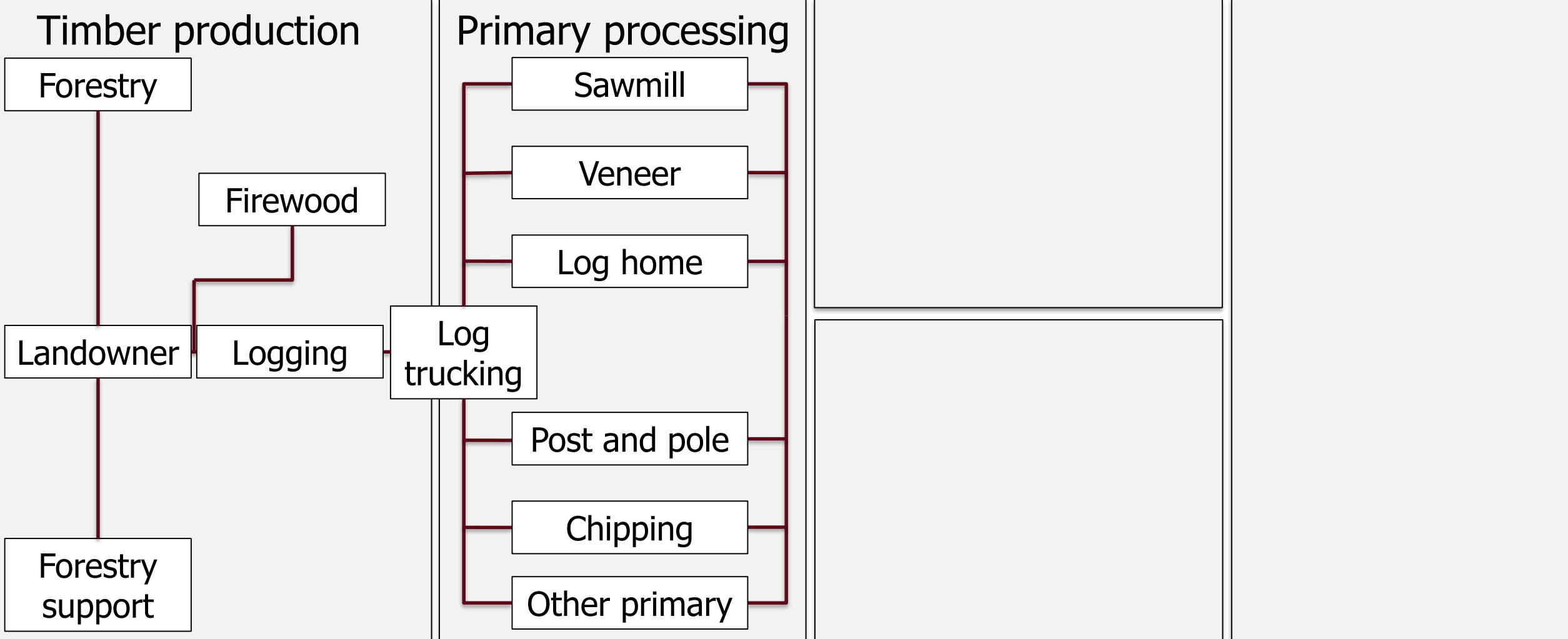

Regional Wood Products Supply Chain

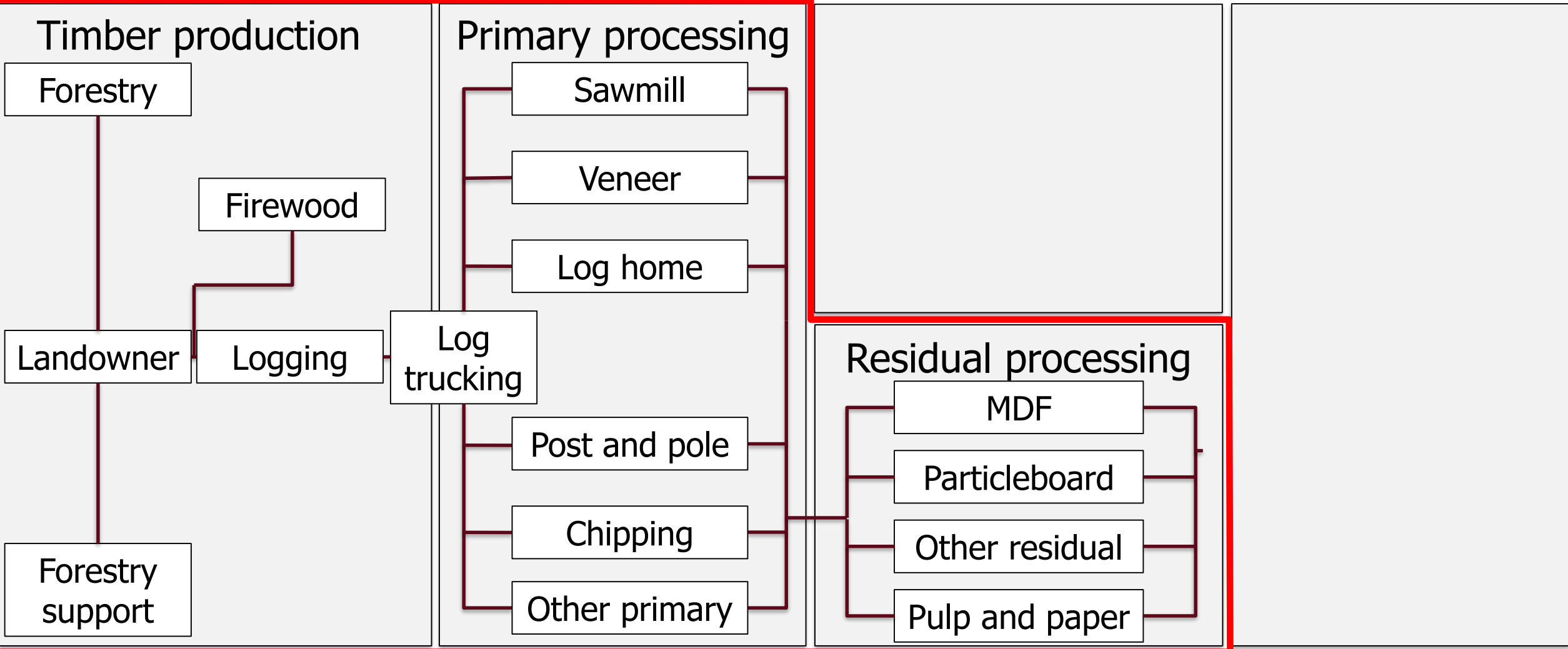

Regional Wood Products Supply Chain

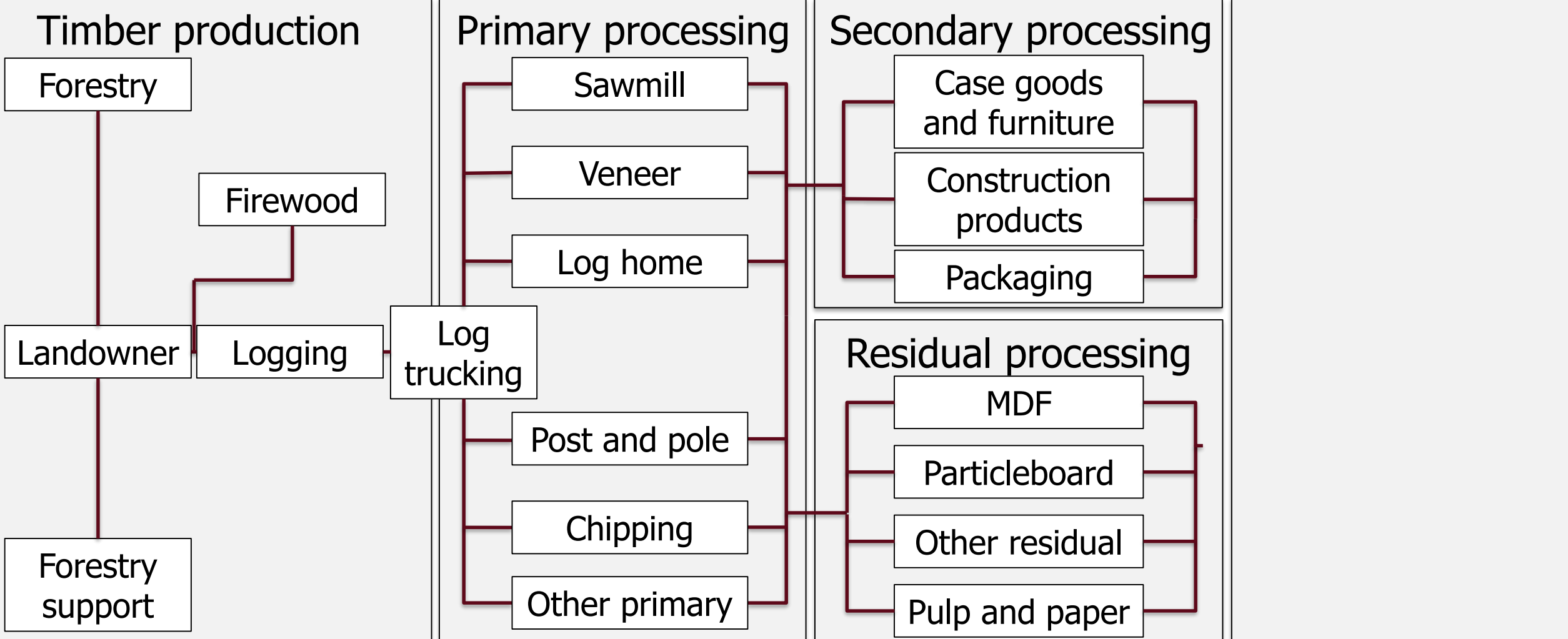

Regional Wood Products Supply Chain

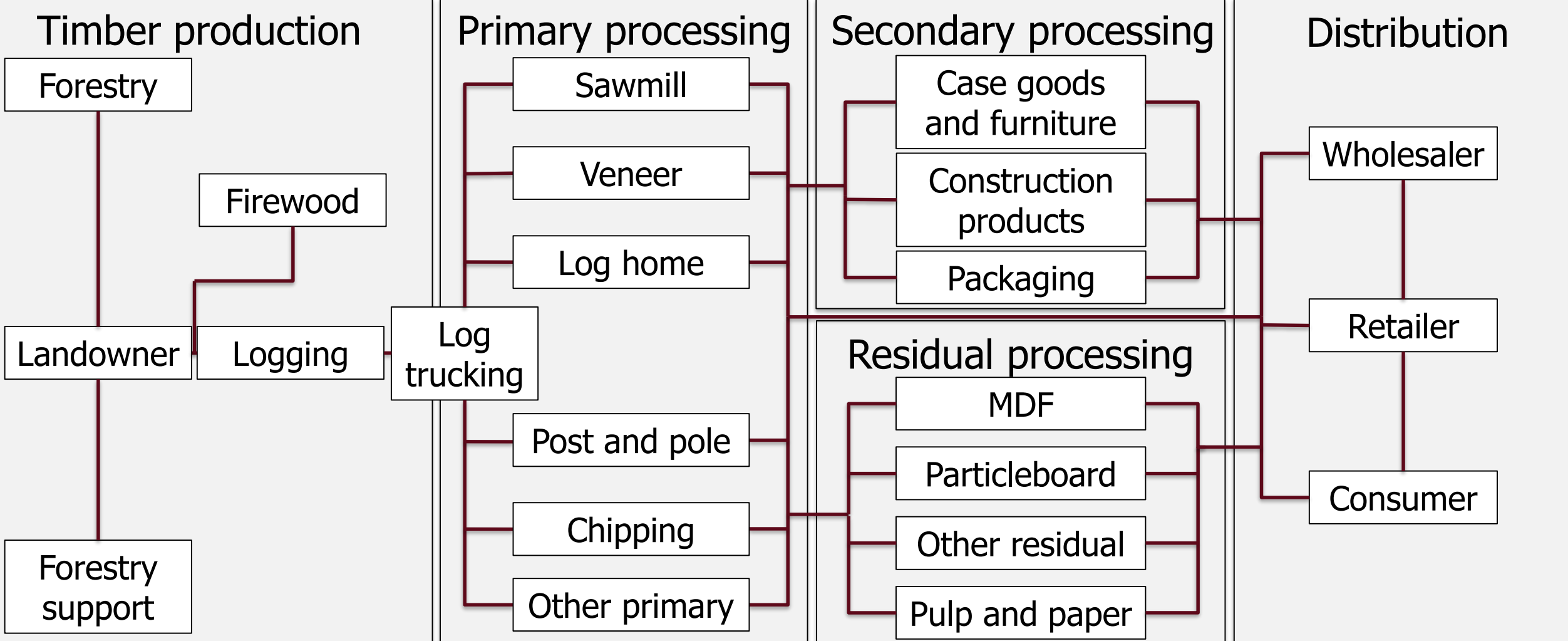

Regional Wood Products Supply Chain

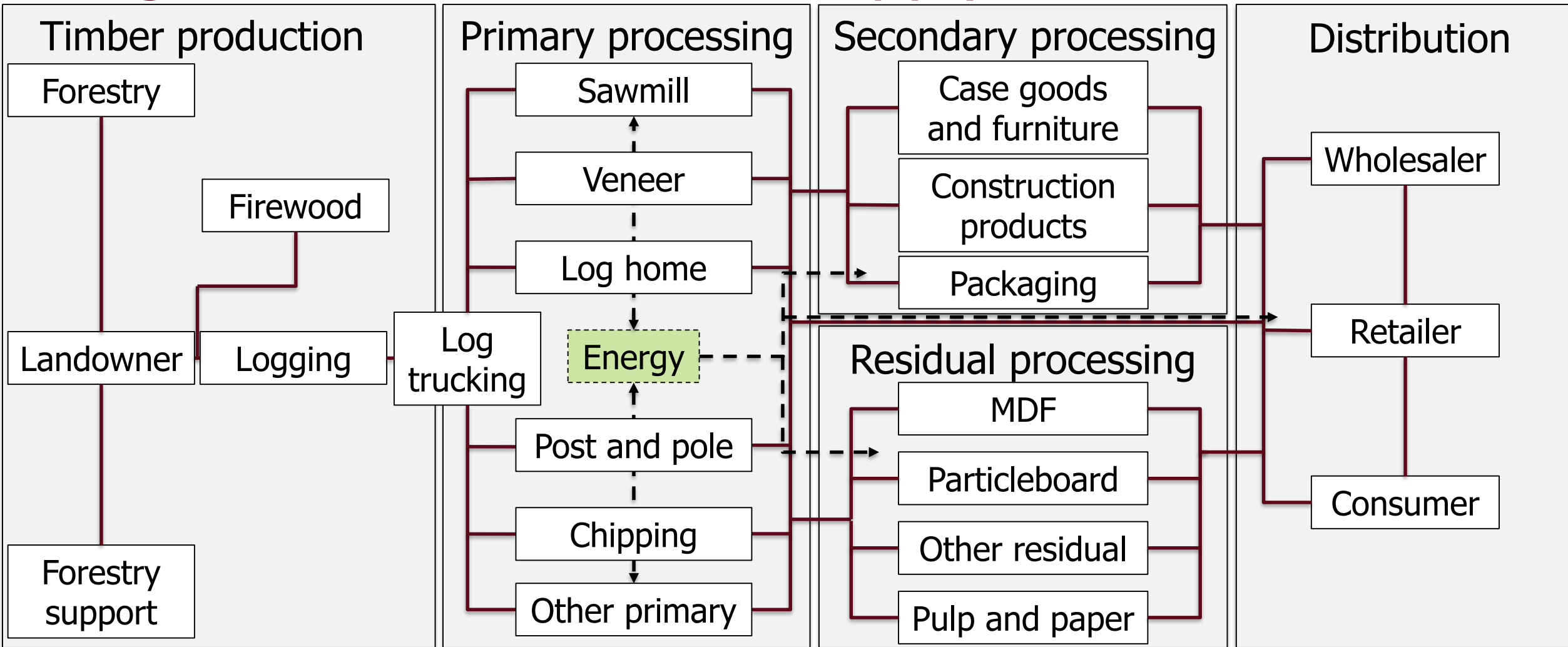

State of the Industry

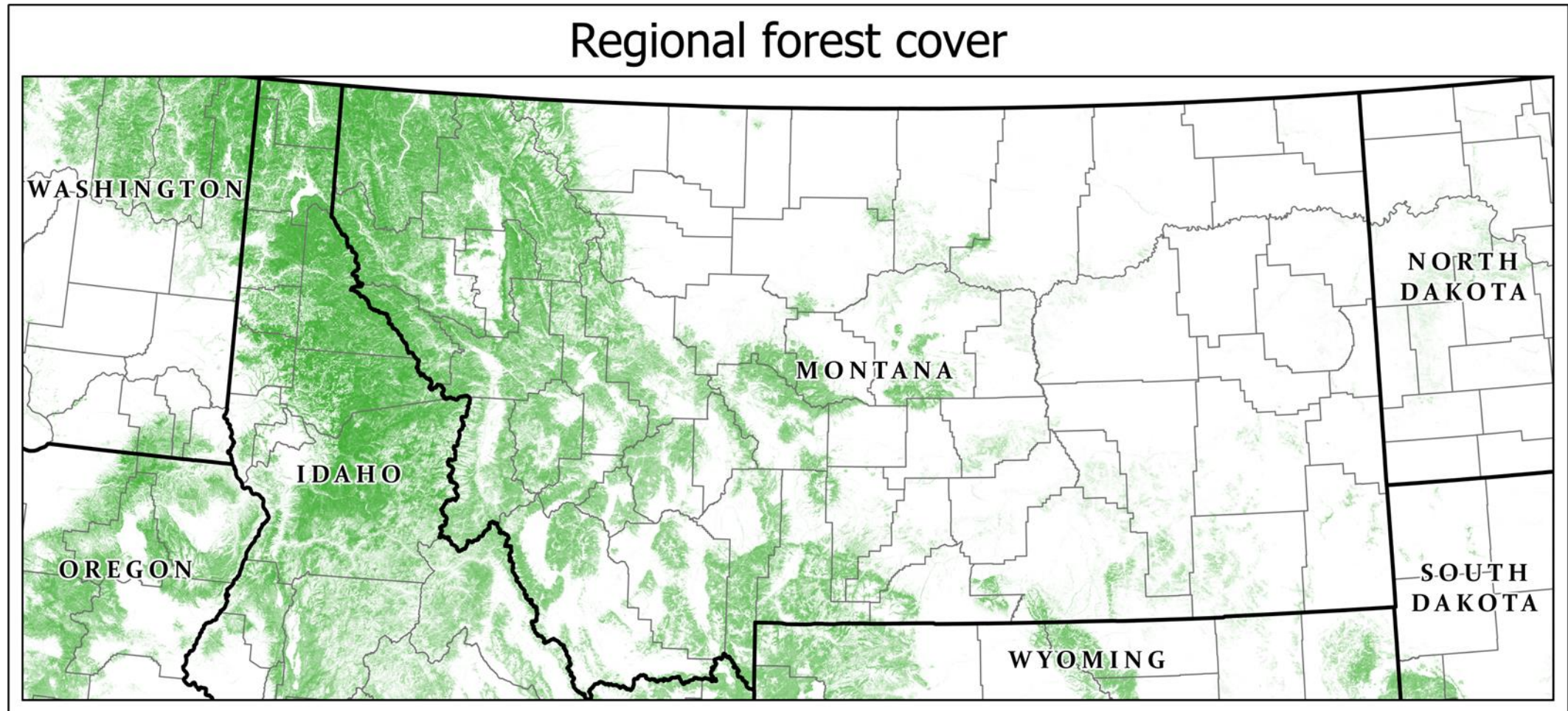

Source: USGS NLCD



**FOREST INDUSTRY
RESEARCH PROGRAM**
UNIVERSITY OF MONTANA

Montana's Forest Products Industry

State of the Industry

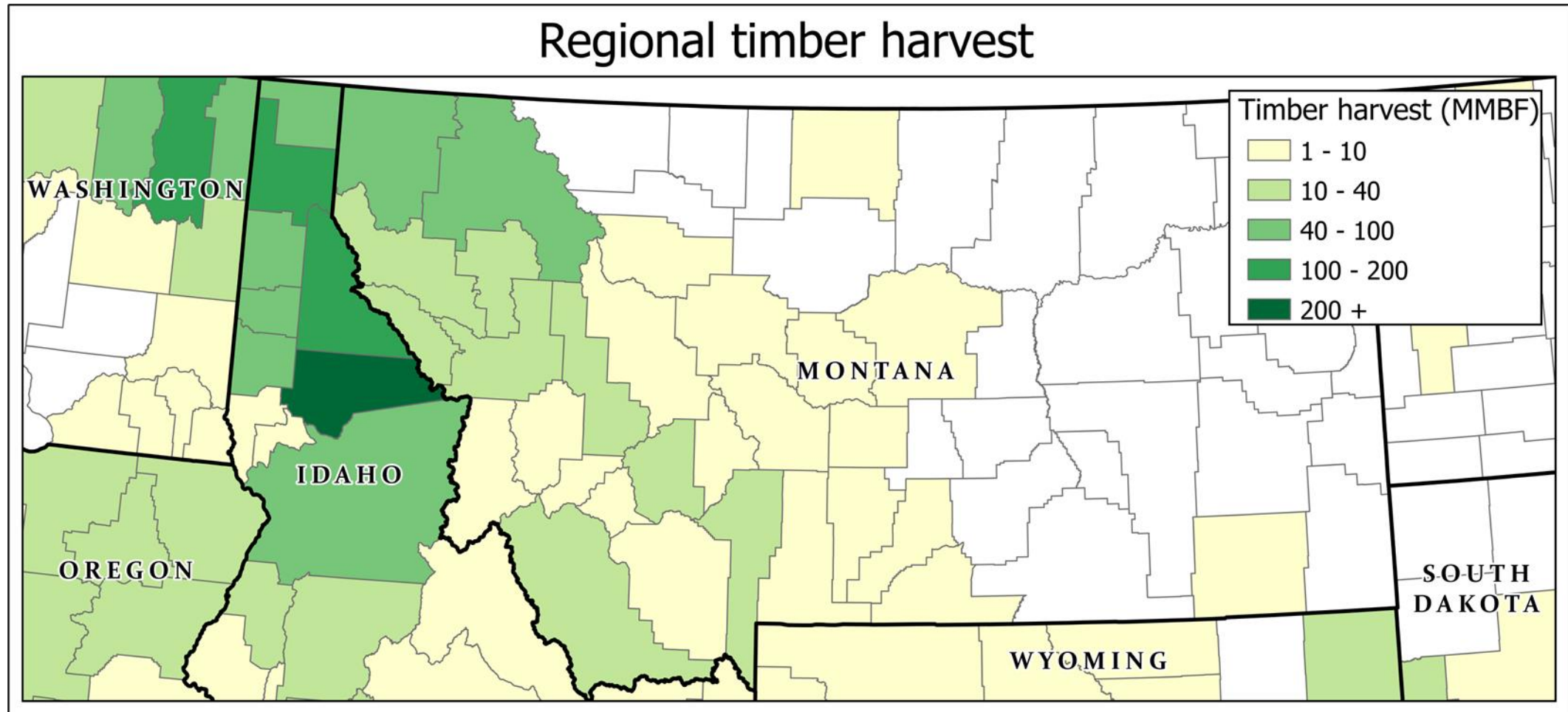

Sources: BBER, USFS NRUMS



**FOREST INDUSTRY
RESEARCH PROGRAM**
UNIVERSITY OF MONTANA

Montana's Forest Products Industry

State of the Industry

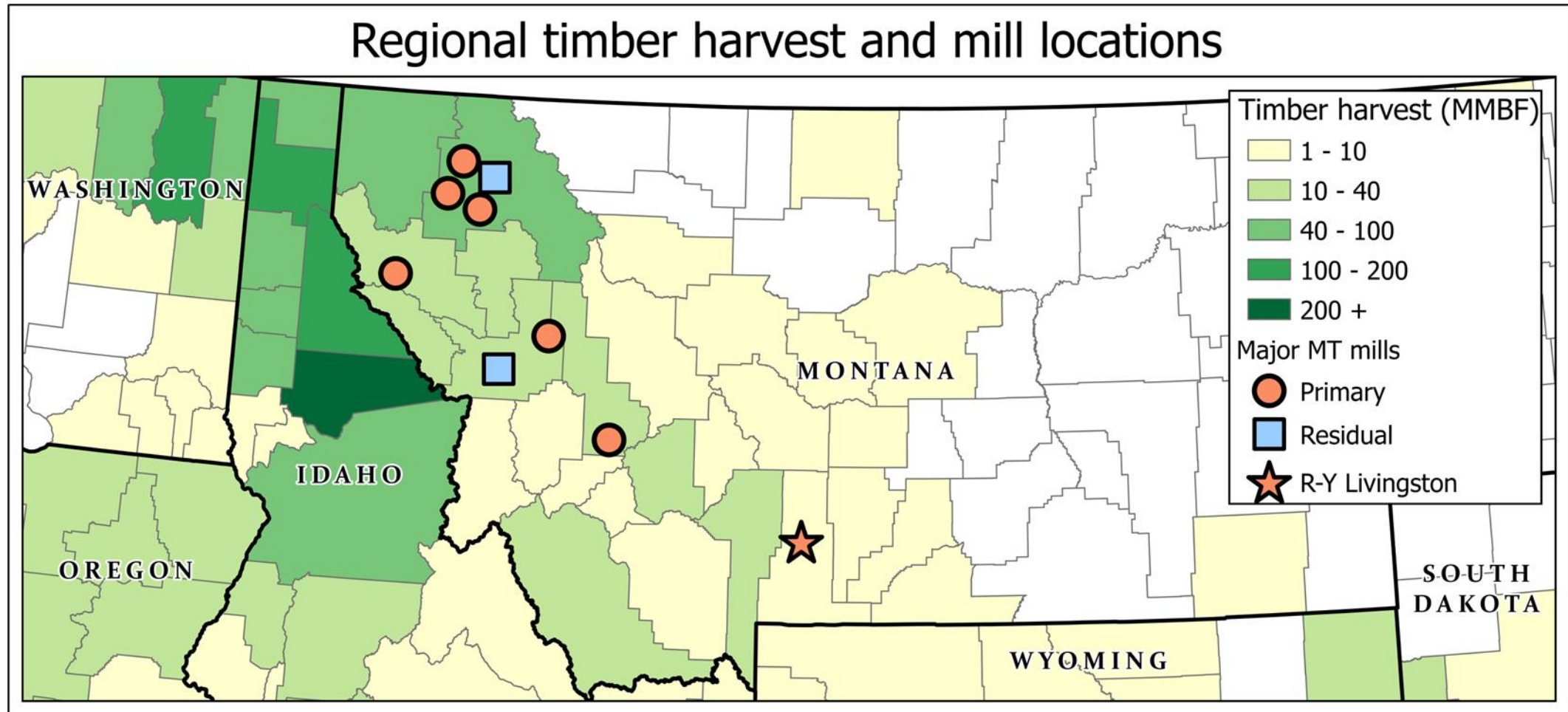

Sources: BBER, USFS NRUMS



**FOREST INDUSTRY
RESEARCH PROGRAM**
UNIVERSITY OF MONTANA

Montana's Forest Products Industry

State of the Industry

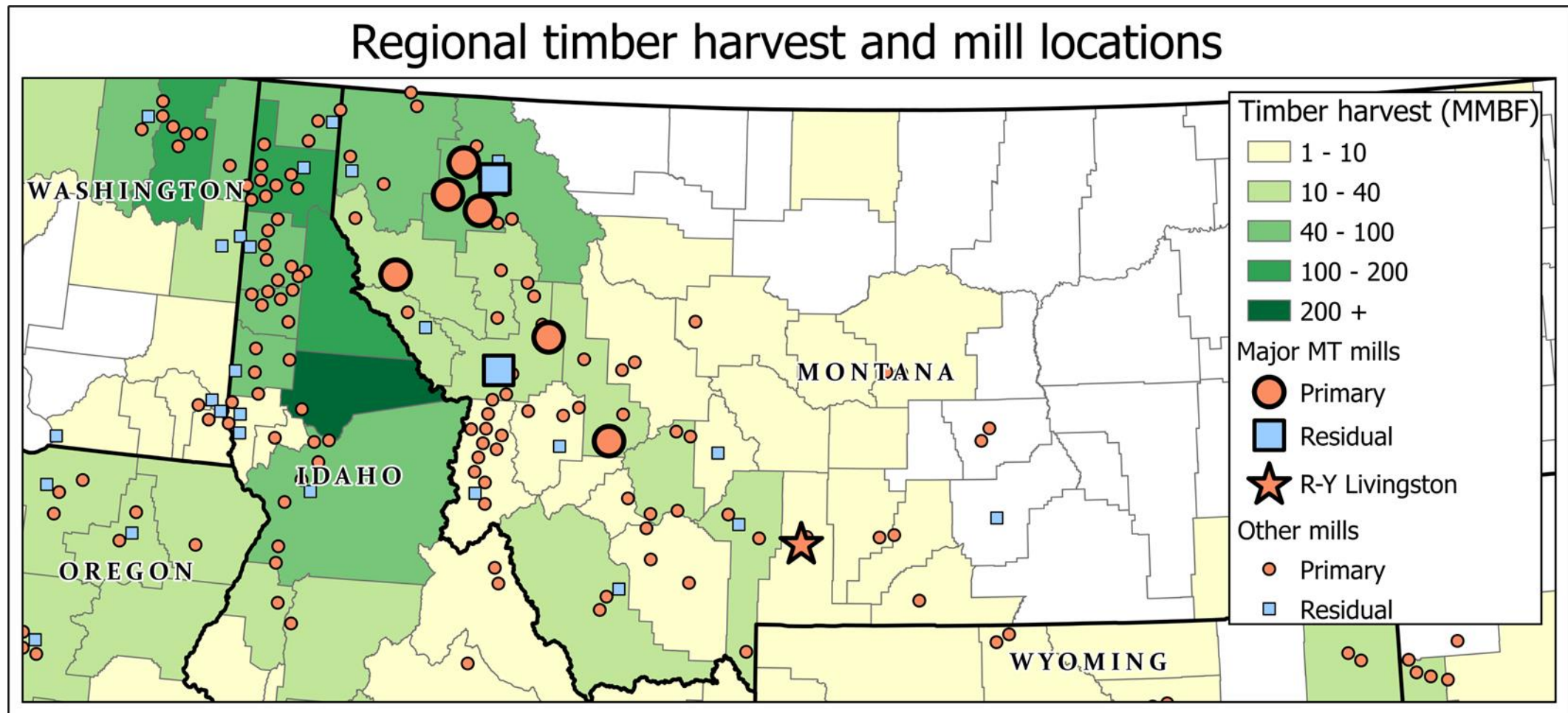

Sources: BBER, USFS NRUMS



**FOREST INDUSTRY
RESEARCH PROGRAM**
UNIVERSITY OF MONTANA

Montana's Forest Products Industry

Trends of the Industry

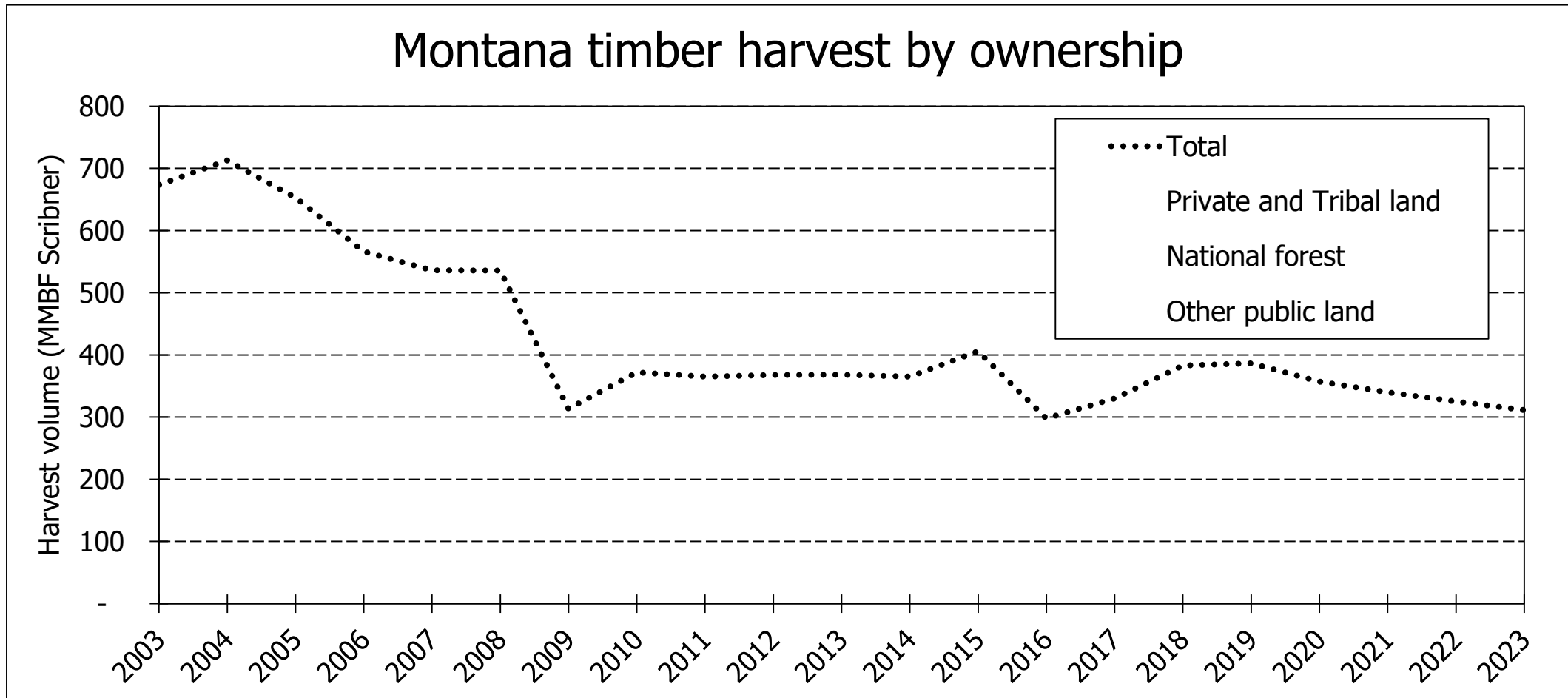

Source: BBER

*2023 estimated



**FOREST INDUSTRY
RESEARCH PROGRAM**
UNIVERSITY OF MONTANA

Montana's Forest Products Industry

Trends of the Industry

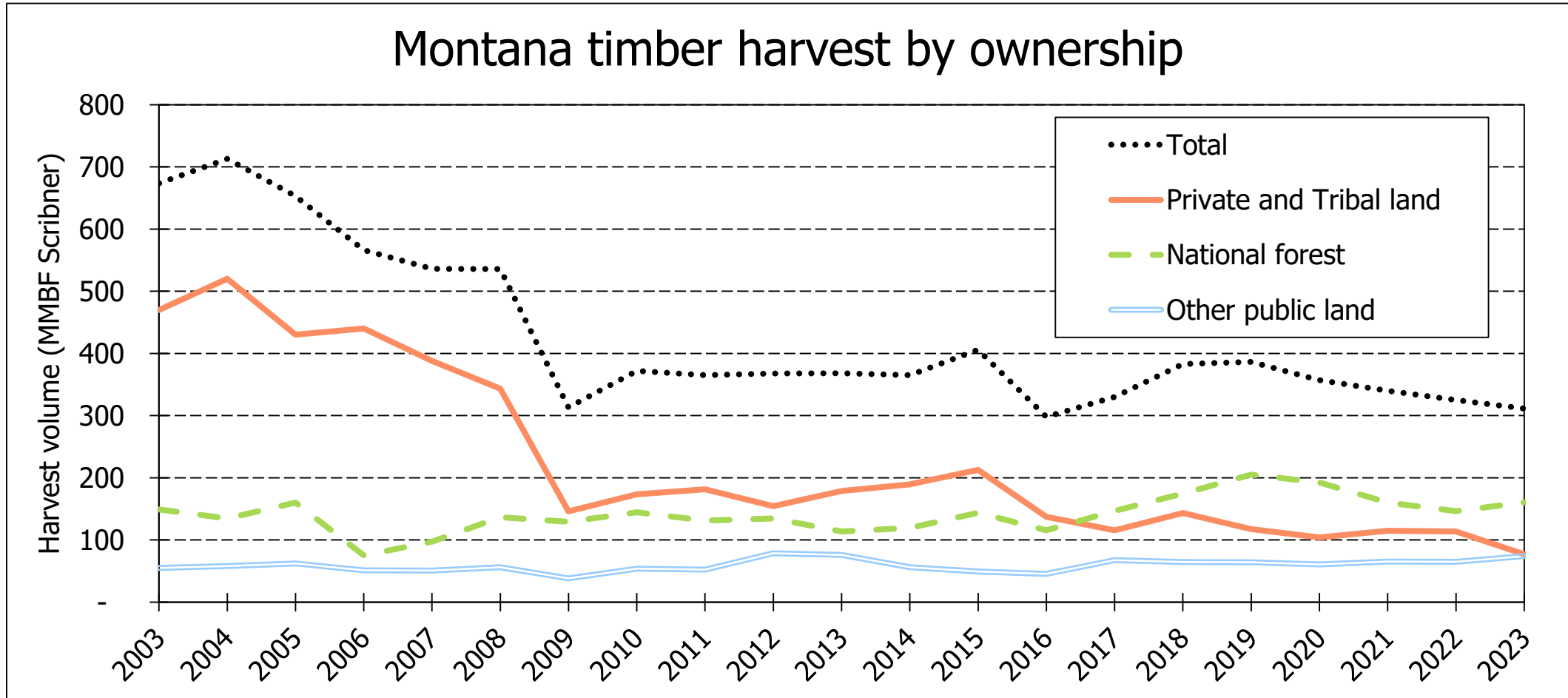

Source: BBER

*2023 estimated



Trends of the Industry

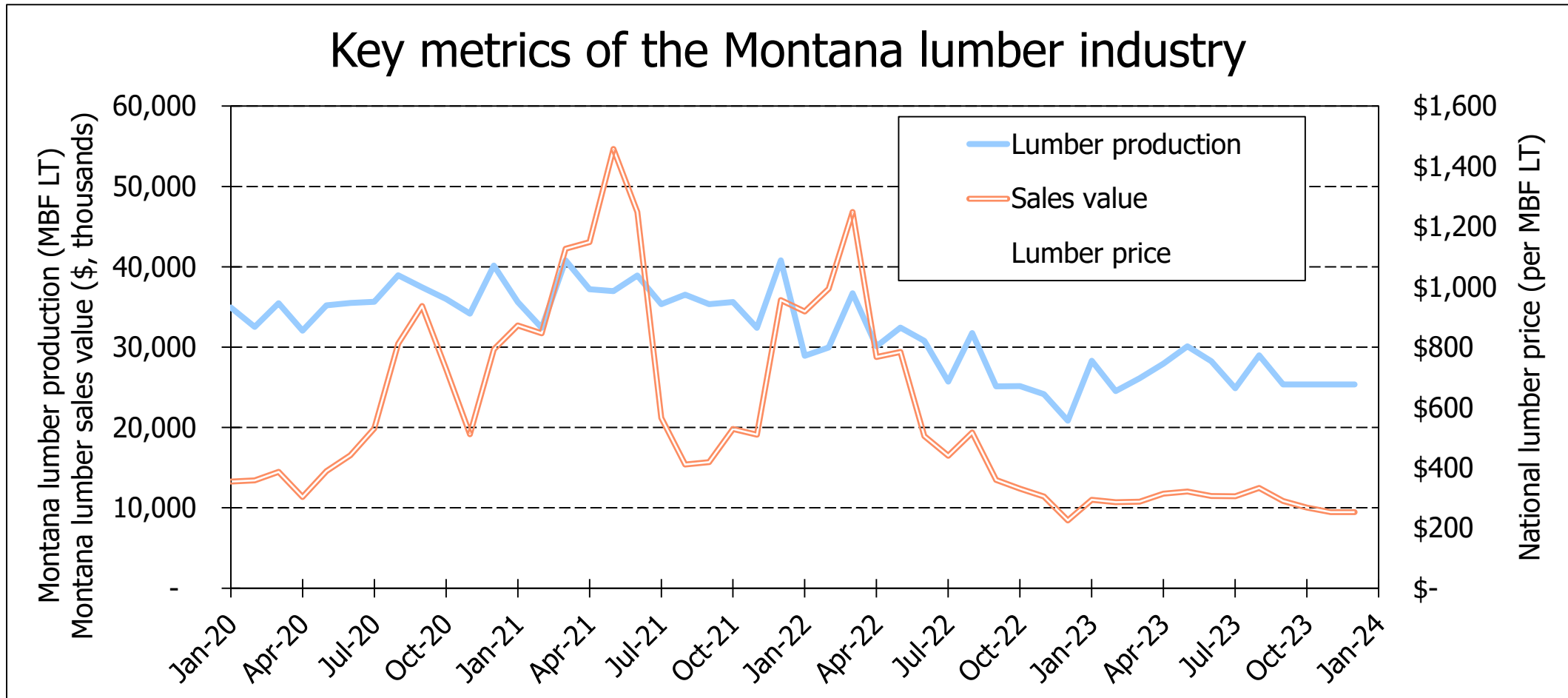

Sources: BBER, Random Lengths

*2023 estimated



Trends of the Industry

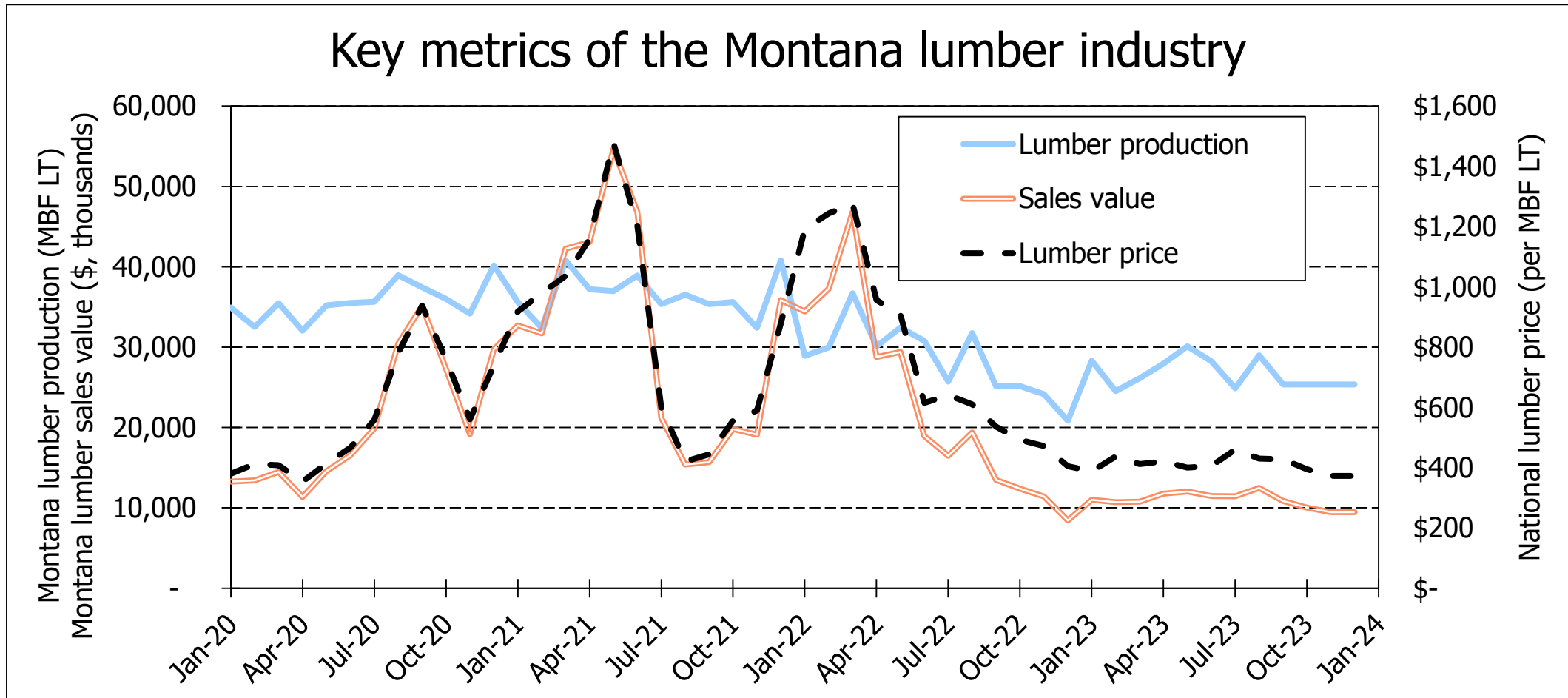

Sources: BBER, Random Lengths

*2023 estimated



Trends of the Industry

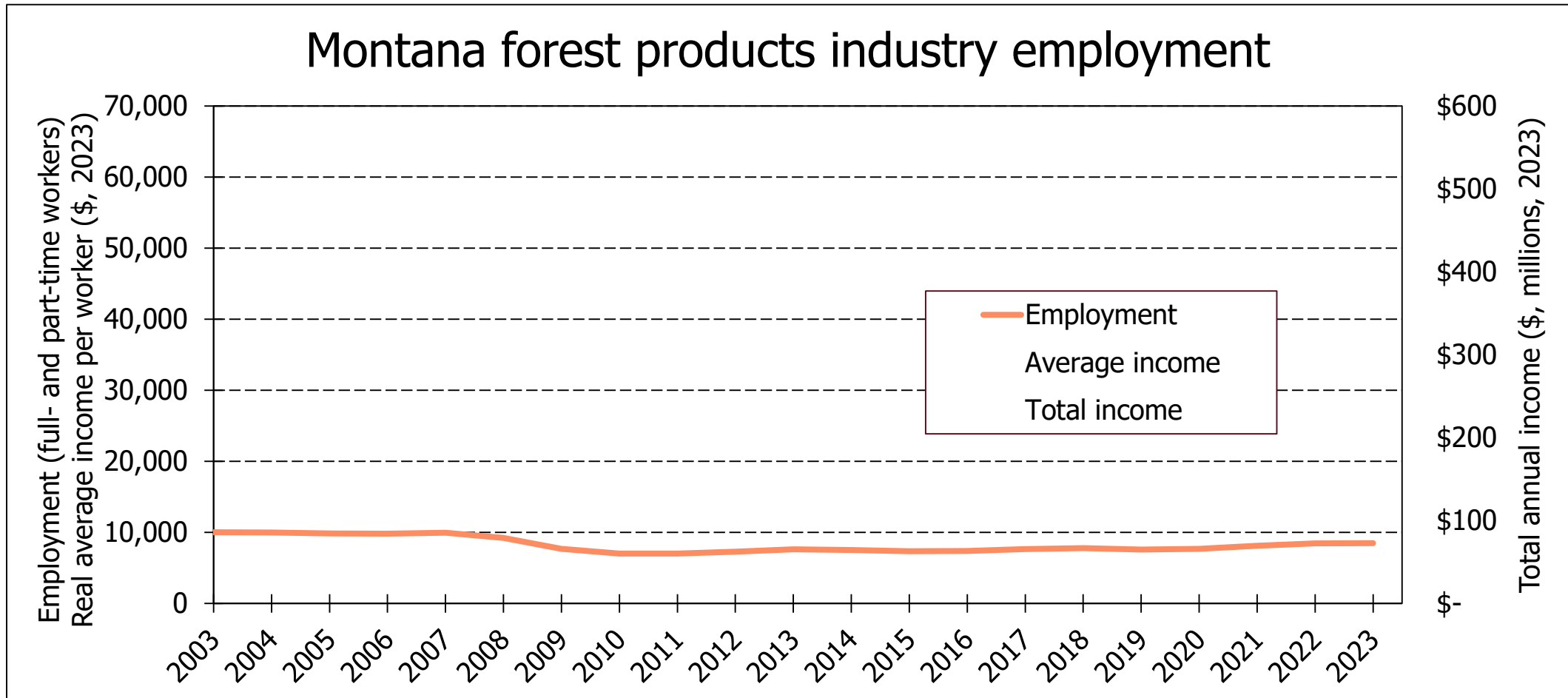

Sources: BBER, USDL BLS, USDC BEA

*2023 estimated



**FOREST INDUSTRY
RESEARCH PROGRAM**
UNIVERSITY OF MONTANA

Montana's Forest Products Industry

Trends of the Industry

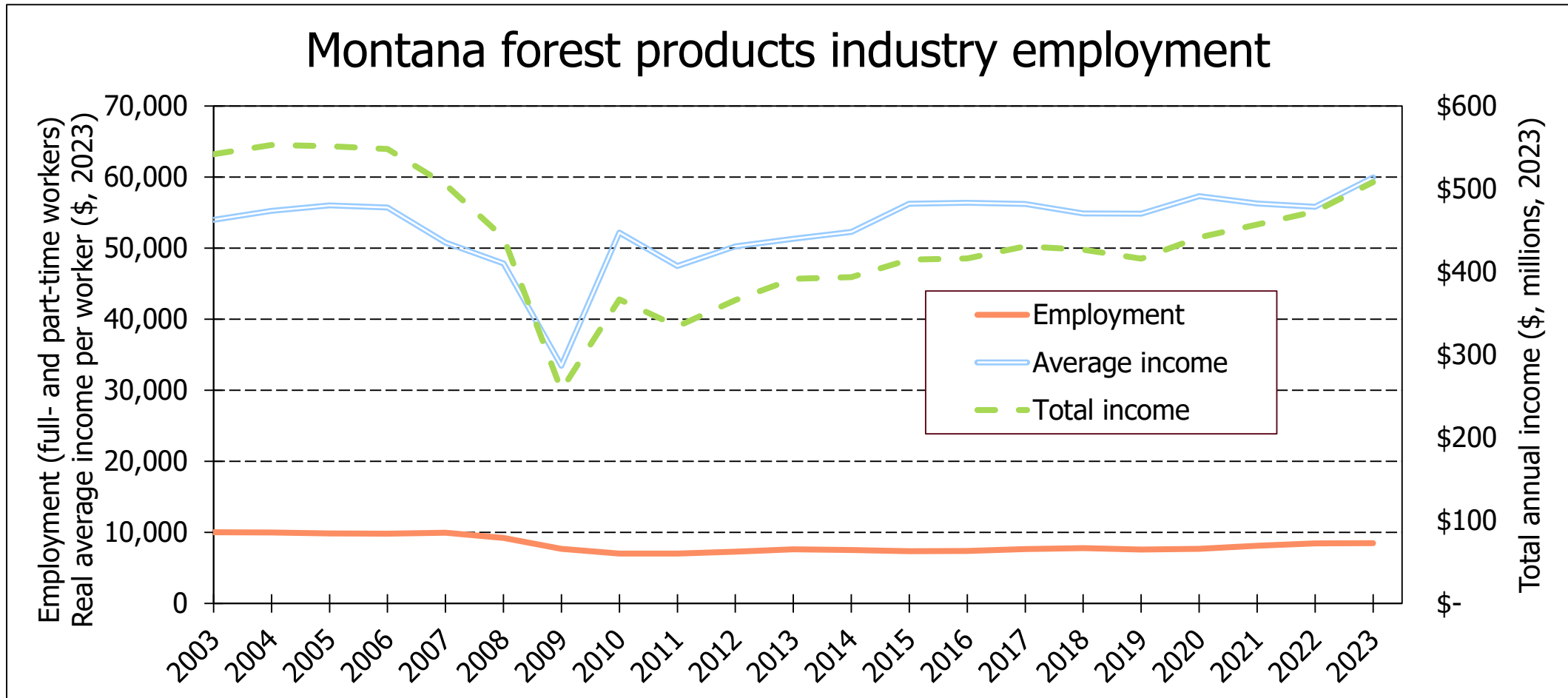

Sources: BBER, USDL BLS, USDC BEA

*2023 estimated



**FOREST INDUSTRY
RESEARCH PROGRAM**
UNIVERSITY OF MONTANA

Montana's Forest Products Industry

Trends of the Industry

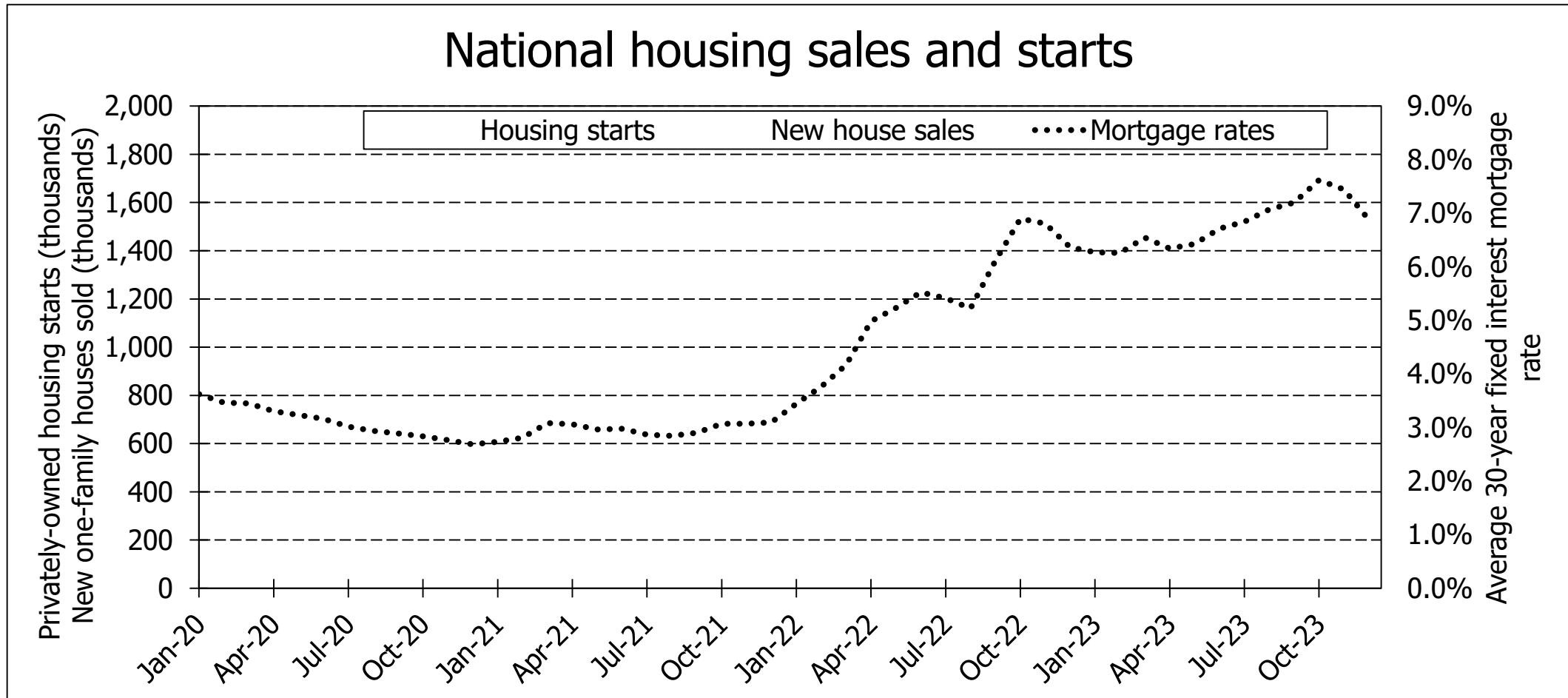

Sources: BBER, USCB, USHUD, Freddie Mac

*2023 estimated



Trends of the Industry

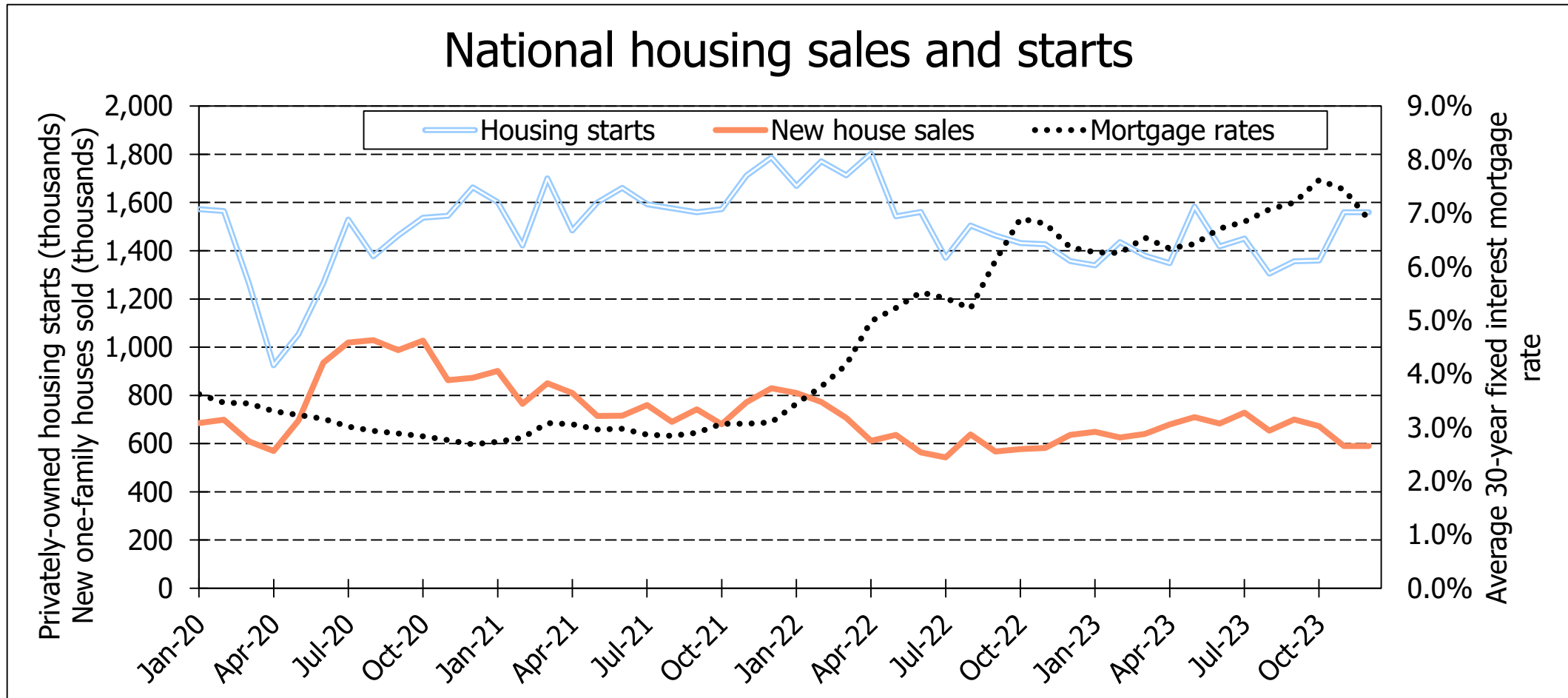

Sources: BBER, USCB, USHUD, Freddie Mac

*2023 estimated



Key Stats

	2003	2013	2022	2023
Timber harvest (MMBF Scribner)	674	368	325	311
Lumber production (MMBF-LT)	1,078	562	342	326
Primary sales (millions, 2023)	\$1,270	\$669	\$639	\$371
Total labor income (millions, 2023)	\$542	\$392	\$473	\$508
Private sector workers	10,033	7,631	8,470	8,479
Labor income per worker (2023)	\$54,010	\$51,314	\$55,819	\$59,952

*2023 estimated



Three Takeaways

- Industry impact is diverse and widespread
- Industry is key to managing our forests
- Housing construction is tied to interest rates, but housing supply is still low



Contact us



samuel.scott@mso.umt.edu

todd.morgan@mso.umt.edu

www.bber.umt.edu/FIR



**FOREST INDUSTRY
RESEARCH PROGRAM**
UNIVERSITY OF MONTANA

Montana's Forest Products Industry